



GENUINE PARTS

INSTALLATION INSTRUCTIONS

1. DESCRIPTION: Illuminated Kick Plate

2. APPLICATION: EX35

3. PART NUMBER: G6950-1BA01

4. KIT CONTENTS:

Item	QTY	Description
A	1	Front kick plate LH
B	1	Front kick plate RH
C	1	Rear kick plate LH
D	1	Rear kick plate RH
E	1	T-harness
F	11	Tie wrap
G	7	Urethane foam tape
H	9	Flat wire protector
I	1	Installation Instructions

A

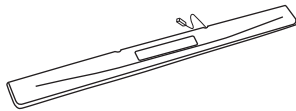

B

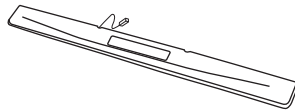

C



D

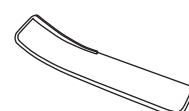

E

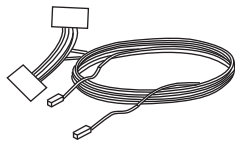

F



G

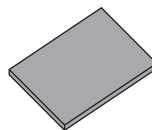

H

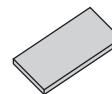

I

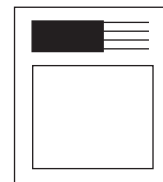

5. TOOLS REQUIRED:

- Nylon removal tool
- Flash light
- 50/50 alcohol & water solution
- Wire cutter
- Fish tape
- Scissors
- Masking tape
- Soap and water
- Soft non linting towel

INSTALLATION INSTRUCTIONS - ILLUMINATED KICK PLATE

6. PRE-INSTALLATION CAUTIONS/NOTES

⚠ CAUTION

- Dealer Installation Recommended. Instructions refer to Service Manual.
- Please read this instruction carefully before installing this product for correct installation.
- Please DO NOT use or install the part in ways other than what is described in this instruction manual.
- If problem occurs during installation, please contact Nissan dealer where you purchased the product.

- 1) Apply Parking Brake.
- 2) Make sure the shift lever is engaged in "P" or "N" position.
- 3) Record customer Radio Presets.

Preset	1	2	3	4	5	6
A						
B						
C						

- 4) Move the front driver and passenger seats to the most rear ward position.
- 5) Use seat and floor protection.
- 6) Open the hood of the vehicle.
- 7) Disconnect the negative battery terminal to prevent short circuits during installation.
- 8) This part is to be installed at a surface temperature of 65-100°F.
- 9) Do not wash the vehicle for 24 hours after installing to prevent the double-sided tape from peeling.

⚠ CAUTION

- Care must be taken not to scratch or damage any components during the removal or replacement process.

- 10) Remove the following interior trim parts in the sequence shown below.

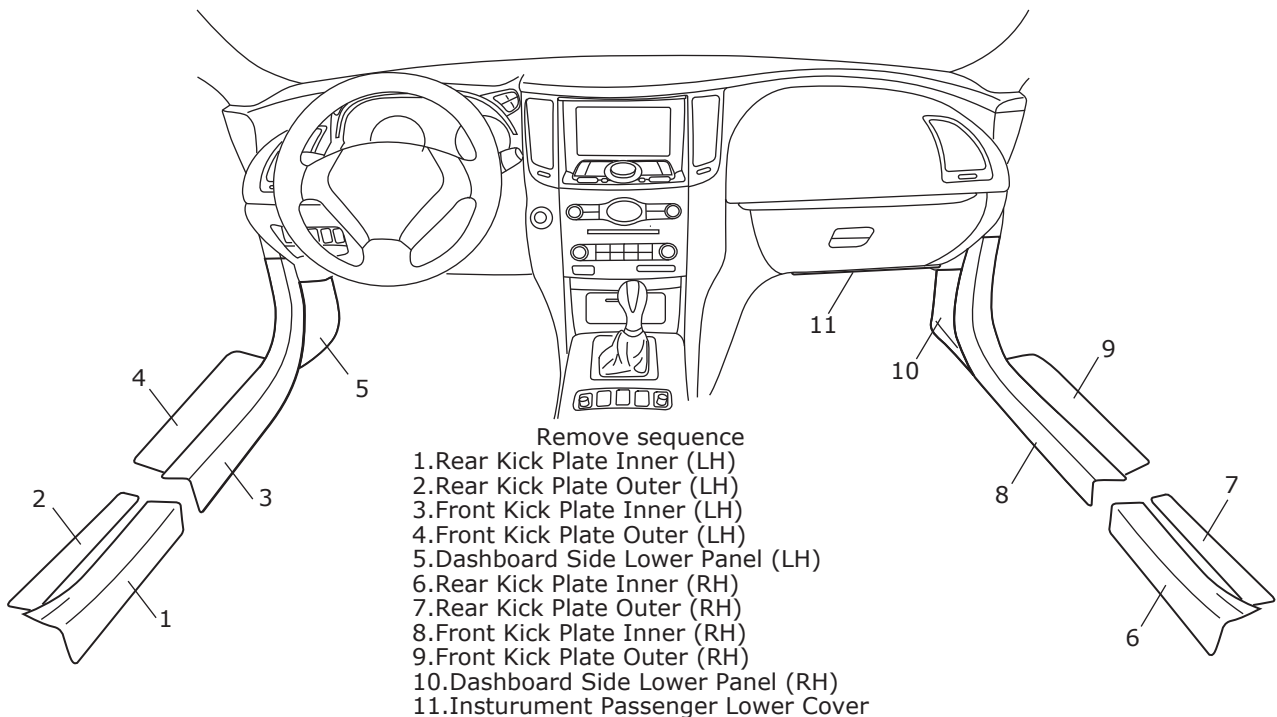

INSTALLATION INSTRUCTIONS - ILLUMINATED KICK PLATE

7. INSTALLATION OUTLINE

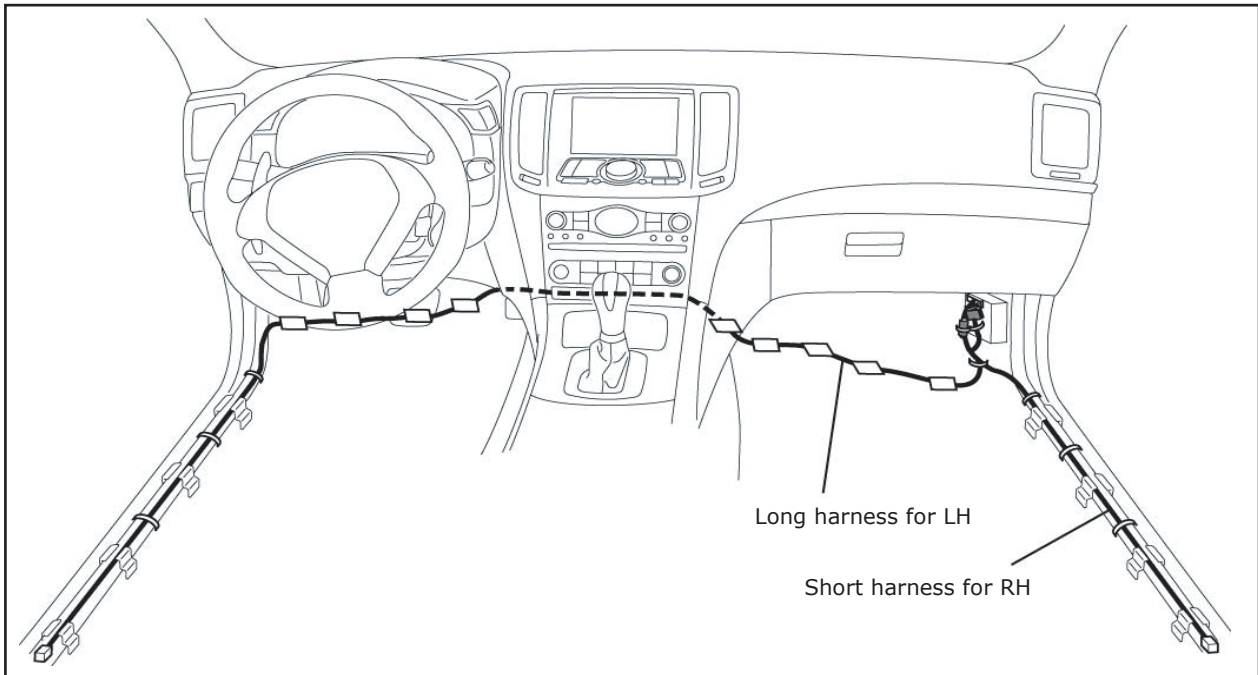

8. STANDARD CONNECTION METHOD

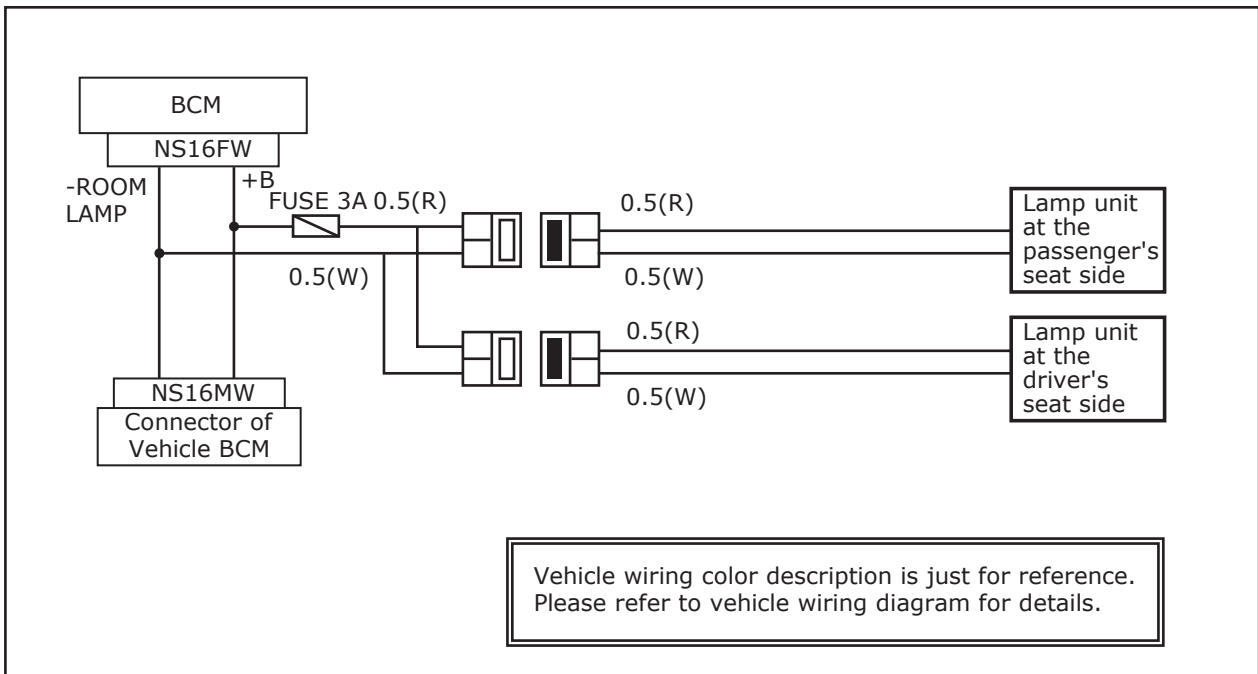

INSTALLATION INSTRUCTIONS - Illuminated Kick Plate

9. VEHICLE PARTS REMOVAL

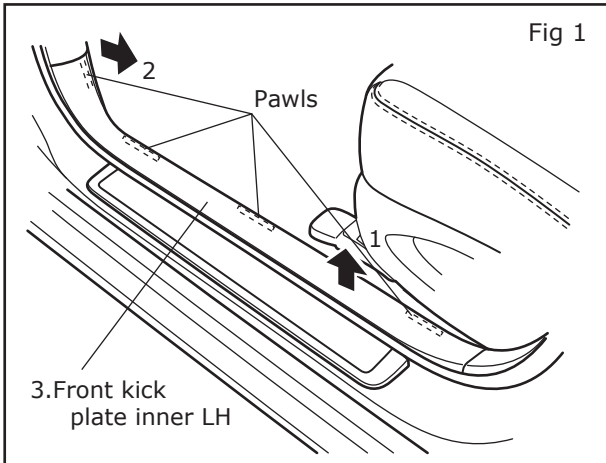

- 1) Front Kick Plate Inner LH removal
 - a) Pull up front kick plate inner LH and disengage pawls. See Fig 1.
 - b) Remove from kick plate inner LH.

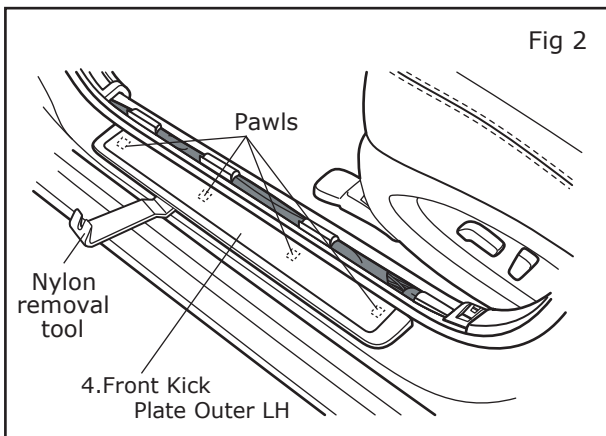

- 2) Front Kick Plate Outer LH removal
 - a) Disengage front kick plate outer mounting pawls with nylon removal tool, then remove front kick plate outer LH (4). Shown in Fig 2.

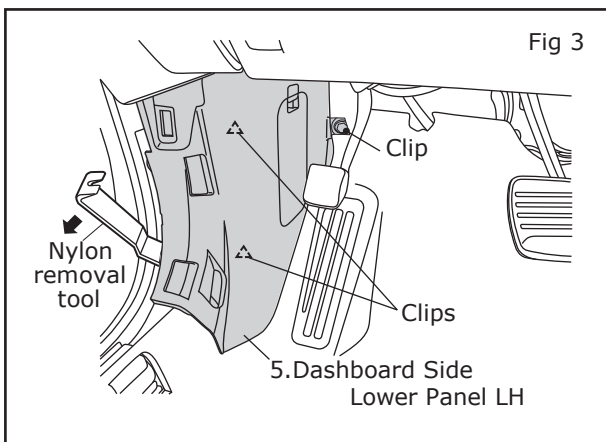

- 3) Dashboard Side Lower Panel LH removal
 - a) Remove clip.
 - b) Disengage dash side finisher mounting clips with nylon removal tool, then remove dashboard side lower panel LH (5). Shown in Fig 3.

- 4) Repeat steps 1)-3) for RH side of vehicle

INSTALLATION INSTRUCTIONS - ILLUMINATED KICK PLATE

9. VEHICLE PARTS REMOVAL CONT'D

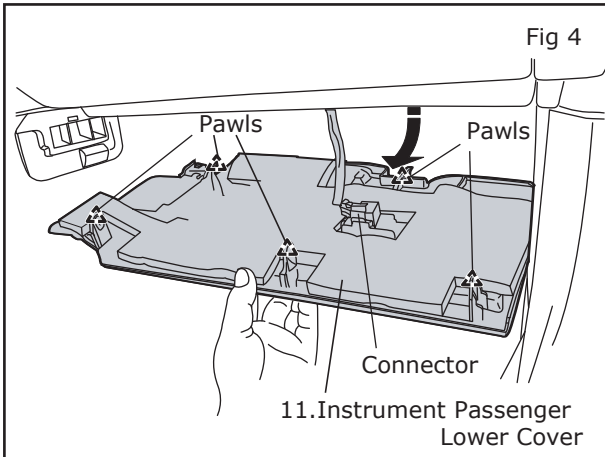

- 5) Instrument Passenger Lower Cover removal
 - a) Pull cover downward to disengage pawls.
 - b) Pull back Instrument Passenger Lower Cover (11). Shown in Fig 4.
 - c) Disconnect connector from the Instrument Passenger Lower Cover(11).

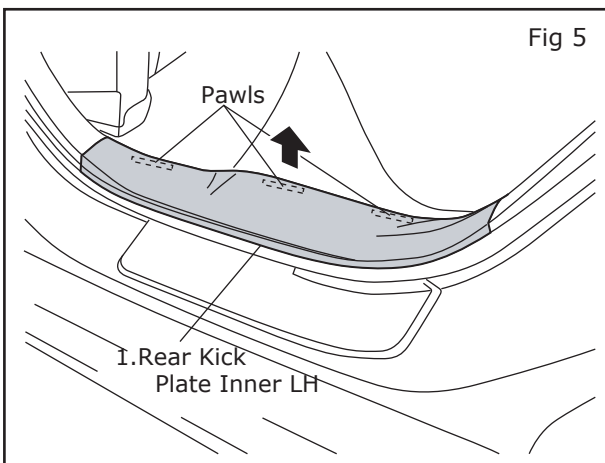

- 6) Rear Kick Plate Inner LH removal
 - a) Pull up rear kick plate inner LH and disengage pawls. See Fig 5.
 - b) Remove from kick plate inner LH.

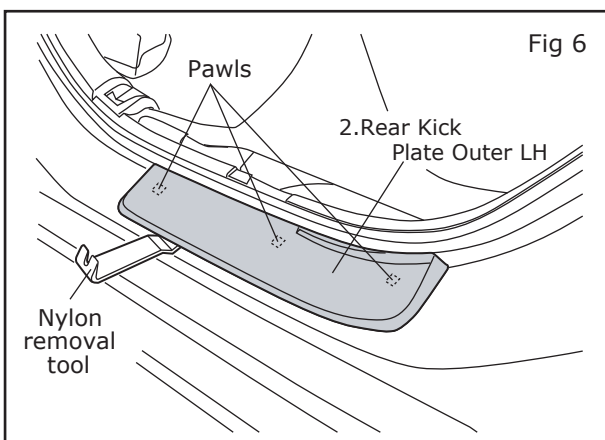

- 7) Rear Kick Plate Outer LH removal
 - a) Disengage rear kick plate outer mounting pawls with nylon removal tool, then remove rear kick plate outer LH (2). Shown in Fig 6.

- 8) Repeat steps 6)-7) for RH side of vehicle

INSTALLATION INSTRUCTIONS - ILLUMINATED KICK PLATE

10. WIRING HARNESS INSTALLATION

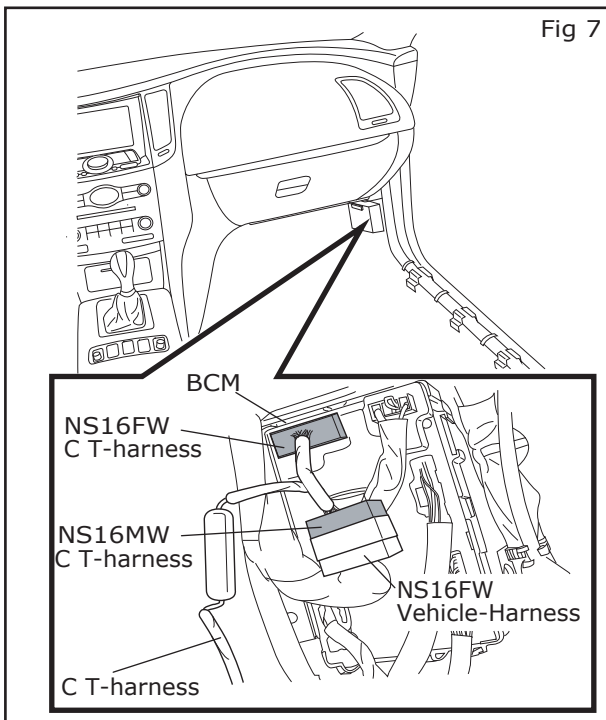

- 1) Disconnect connector (NS16FW) from the BCM.
- 2) Connect connector (NS16FW) on T-harness (E) to the BCM. Shown in Fig 7.
- 3) Connect the connector (NS16FW) which was disconnected from the BCM to the T-harness (E) Shown in Fig 7.

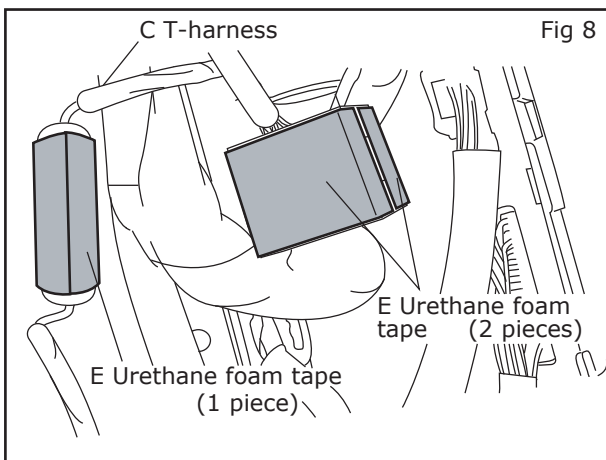

- 4) Wrap the connected connector with two pieces of Urethane foam tape (G). Shown Fig 8.
- 5) Wrap the fuse of T-harness (E) with one piece of Urethane foam tape (G). Shown Fig 8.

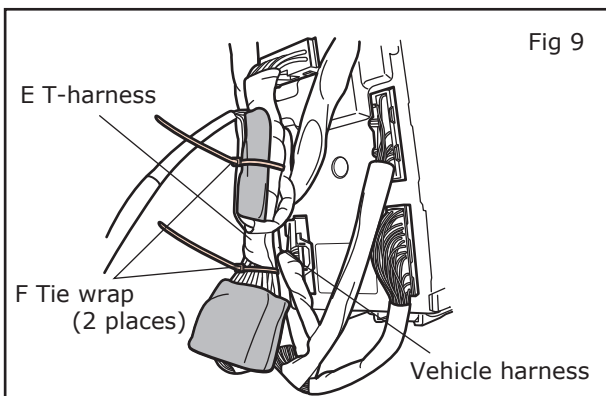

- 6) Secure the fuse to T-harness (E) at the position shown in Fig 9, using the tie wrap (F).
- 7) Secure the connected connector to vehicle harness at the position shown in Fig 9, using the tie wrap (F).

INSTALLATION INSTRUCTIONS - ILLUMINATED KICK PLATE

10. WIRING HARNESS INSTALLATION CONT'D

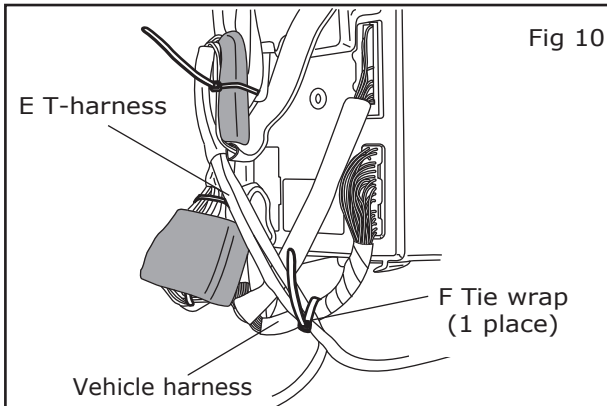

- 8) Secure the T-harness(C) to vehicle harness at the position shown in Fig 10, using the Tie wrap (F).

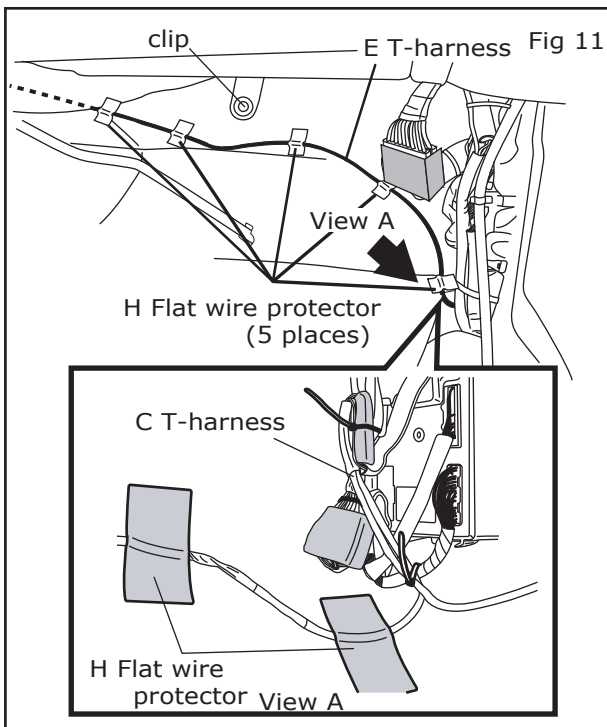

- 9) Remove one clip from front passenger side carpet. Shown in Fig 11.

- 10) Flip the carpet of passenger side.

- 11) Route fish tape behind center console from driver's side harness to passenger side.

- 12) Attach harness to fish tape.

- 13) Pull harness with fish tape behind center console.

- 14) Put a flat wire protector (F) near a tie wrap (D) of view A without pulling harness. (1place)

- 15) Attach passenger side harness using the flat wire protector (F) shown in Fig 11. (4places)

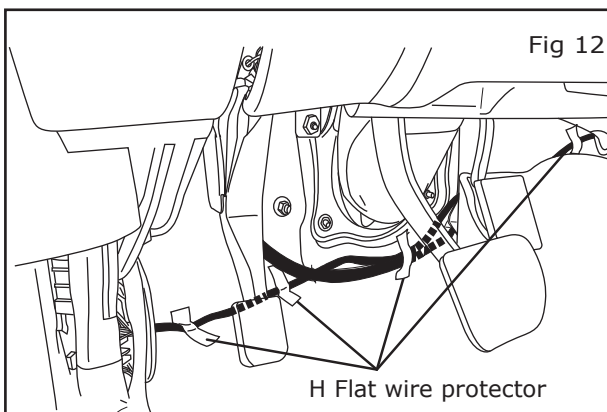

- 16) Flip the carpet of the driver's side, route harness under the accelerator pedal bracket and attach harness to floor using flat wire protector (H) shown in Fig 12. (4places)

INSTALLATION INSTRUCTIONS - ILLUMINATED KICK PLATE

10. WIRING HARNESS INSTALLATION CONT'D

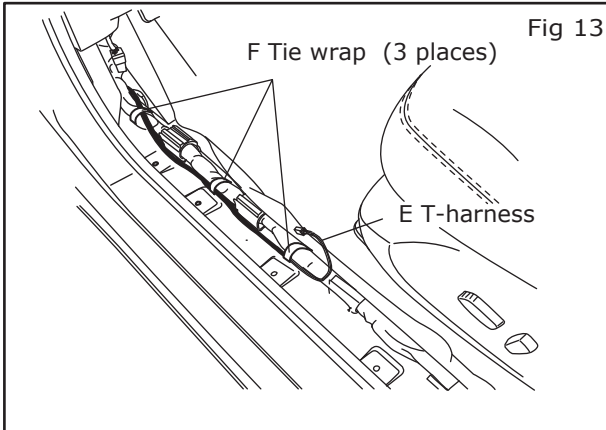

17) Route driver side harness through existing vehicle harness protector and Tie Wrap (F) the harness at the position shown in Fig 13. (3 places)

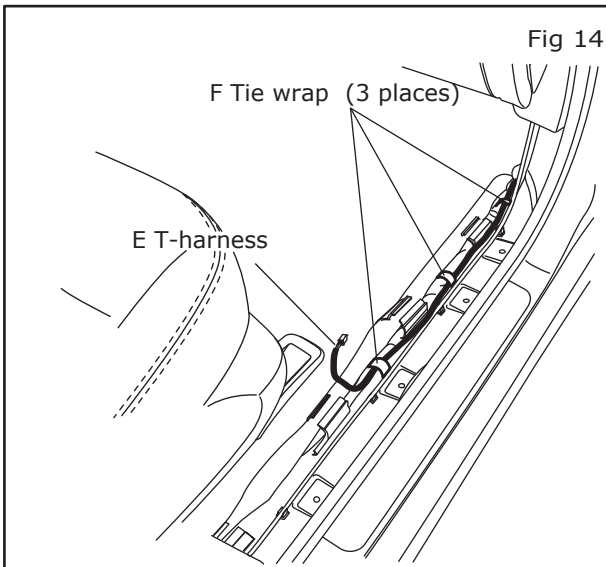

18) Route passenger side harness through existing vehicle harness protector and fix the harness at the position shown in Fig 14, using the Tie Wrap (F). (3places)

19) Function check

- a) Connect T-harness to kick plate lamp unit harness.
- b) Connect battery.
- c) Check function. Confirm "INFINITI" text illuminates when either door is open.
- d) If OK, disconnect T-harness from kick plate harness.
- e) If NG, check harness routine, connections and lamp unit to identify root cause and fix it. Repeat steps a) to c) until it is OK.
- f) Disconnect battery.

INSTALLATION INSTRUCTIONS - ILLUMINATED KICK PLATE

11. FRONT KICK PLATE INSTALLATION

The procedure below shows the installation for LH side.
Repeat procedure for RH side.

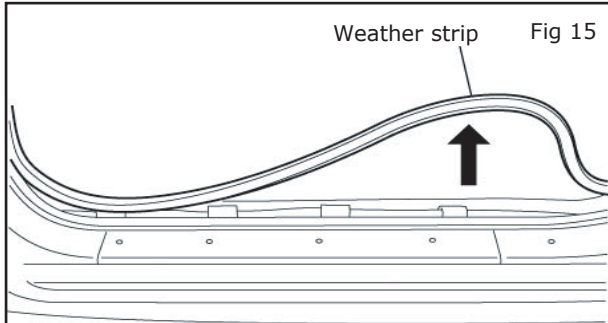

- 1) Remove the vehicle weather strip near the front kick Plate (A) attachment location shown in Fig 15.
- 2) Clean the attachment area of front Kick Plate (A) with soapy water.
- 3) Dry area with soft non linting towel.
- 4) Clean area with 50/50 alcohol & water solution and let dry for 30 seconds.

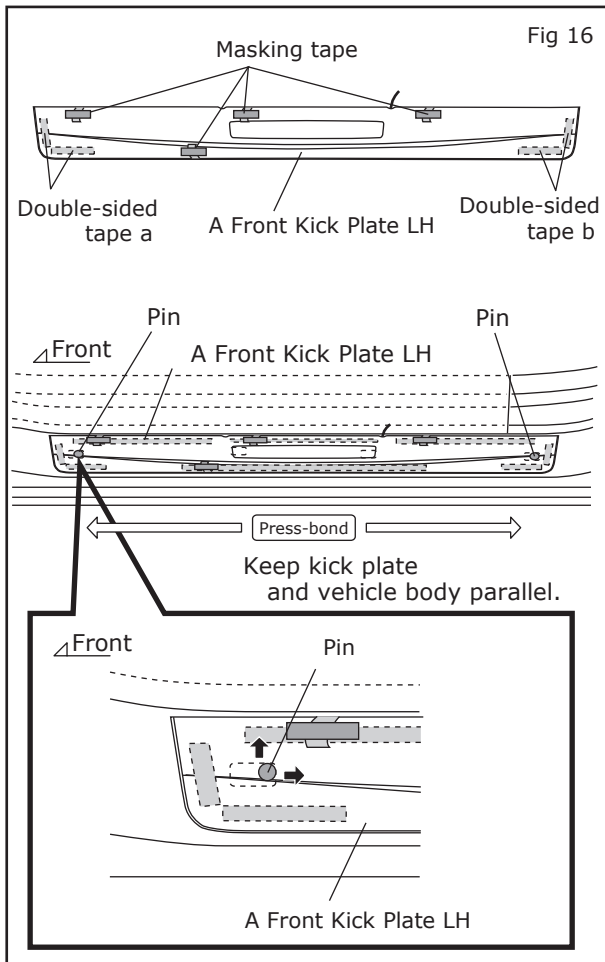

- 5) Remove double-sided tape's liner from kick plate at location a and b shown in Fig 16.

! CAUTION

- Use caution when applying pressure as the surface may dent.
- During installation, be careful not to allow the harness to get stuck between the vehicle and the kick plate.
- Harness should be routed through the notched area of the kick plate.

- 6) Pull the adhesive tape liner pull tab to partially remove liner from all other locations. Using masking tape, hold the liner to the visible side of the kick plate surface as shown in Fig 16.
- 7) Align pins on kick plate to first and fourth hole on vehicle from front side. Push the pins toward the rear and inner side of the vehicle.
- 8) Set kick plate on vehicle, being careful to keep the outside edge of the part parallel to the rocker panel.
- 9) Gradually remove the tape liners at the back of the front kick plate (A) starting from the front.
- 10) Apply minimum 11lb(49N) of pressure along the kick plate to attach tape to body shown in Fig 16.

INSTALLATION INSTRUCTIONS - ILLUMINATED KICK PLATE

- 12. HARNESS CONNECTION INSTALLATION** The procedure below shows the installation for LH side. Repeat procedure for RH side.

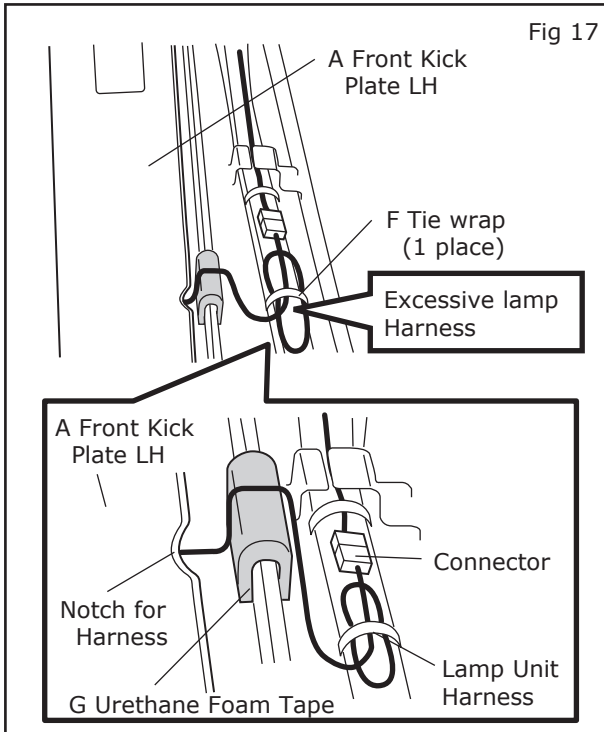

- 1) Fold one piece urethane foam tape (G) and cut into two equal pieces.
- 2) Clean both sides of the attachment area for the urethane foam tape (G) with the 50/50 alcohol & water solution. Let dry for 30 seconds. Shown in Fig 17.

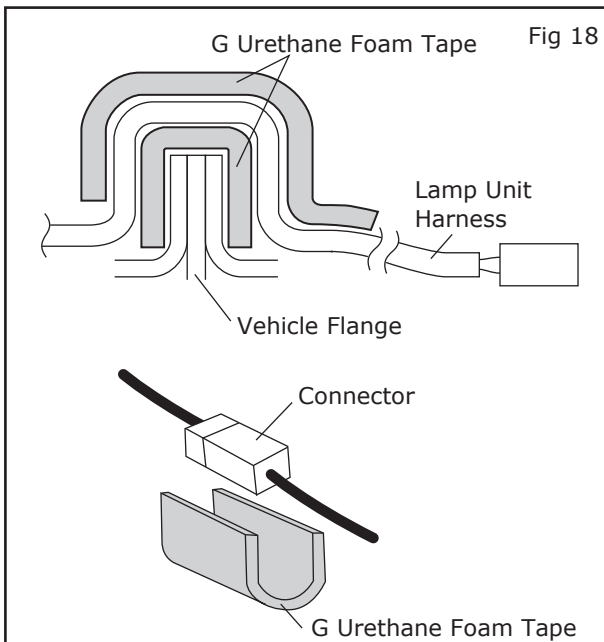

- 3) Attach the cut piece of urethane foam tape (G) to vehicle flange shown in Fig 18.
- 4) Place the lamp harness on top of the urethane foam tape (G), then apply second half of the urethane foam tape (G) on top of the harness.
- 5) Connect the connectors and apply the urethane foam tape (G) on the connecting section shown in fig 18.
- 6) Attach excessive lamp harness to the vehicle harness with a tie wrap (F) shown in Fig 17
- 7) Cut excessive tie wrap.

⚠ CAUTION

- Do not attach the harness to sharp metal edge.

INSTALLATION INSTRUCTIONS - ILLUMINATED KICK PLATE

13. REAR KICK PLATE INSTALLATION

The procedure below shows the installation for LH side. Repeat procedure for RH side.

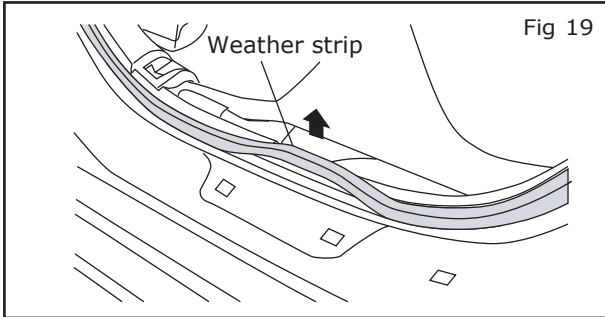

- 1) Remove the vehicle weather strip near the rear kick plate LH (C) attachment location shown in Fig 19.
- 2) Clean the attachment area of rear kick plate LH (C) with soapy water.
- 3) Dry area with soft non linting towel.
- 4) Clean area with 50/50 alcohol & water solution and let dry for 30 seconds.

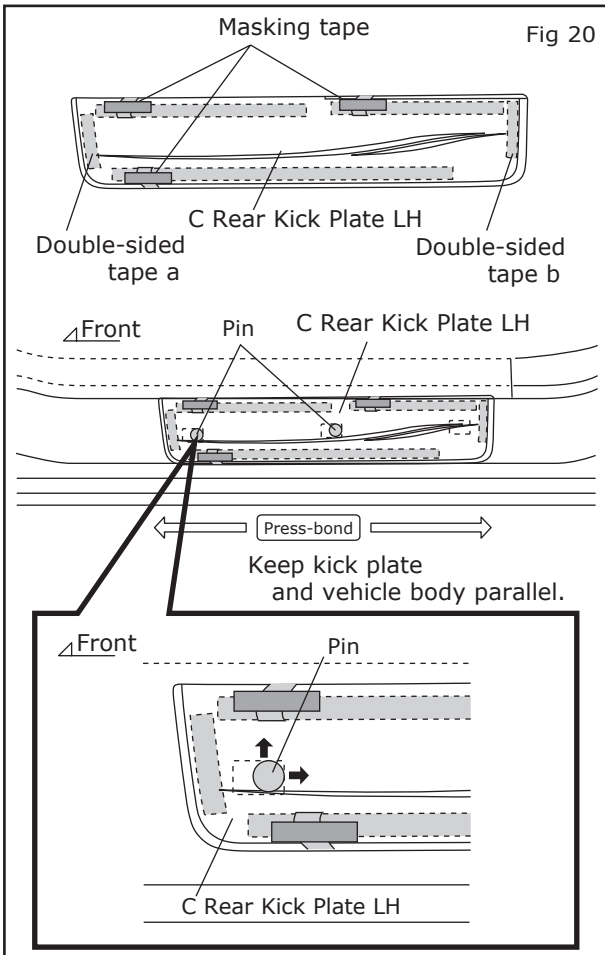

- 5) Remove double-sided tape's liner from kick plate at location a and b shown in Fig 20.

CAUTION

- Use caution when applying pressure as the surface may dent.
- During installation, be careful not to allow the harness to get stuck between the vehicle and the kick plate.
- Harness should be routed through the notched area of the kick plate.

- 6) Pull the adhesive tape liner pull tab to partially remove liner from all other locations. Using masking tape, hold the liner to the visible side of the kick plate surface as shown in Fig 20.
- 7) Align pins on kick plate to first and second hole on vehicle from front side. Push the pins toward the rear and inner side of the vehicle.
- 8) Set kick plate on vehicle, being careful to keep the outside edge of the part parallel to the rocker panel.
- 9) Gradually remove the tape liners at the back of the rear kick plate (C) starting from the front.
- 10) Apply minimum 11lb(49N) of pressure along the kick plate to attach tape to body shown in Fig 20.

INSTALLATION INSTRUCTIONS - ILLUMINATED KICK PLATE

14. CHECK AFTER INSTALLATION

- 1) Please check that the installation has no problem.
- a) confirm connection of connector
 - b) confirm whether wire harness is fixed.

15. FUNCTION CHECK

- 1) Re-connect battery negative terminal.
- 2) Confirm "INFINITI" text is illuminated when either door is in the opened position.

16. REINSTALLATION OF REMOVED PARTS

- 1) All removed vehicle parts have been reinstalled.

CAUTION

Use caution when re-installing interior components to avoid damage, scratch, or breaking of mounting clips.

- 2) Clean interior of vehicle.

17. VEHICLE CHECK

- 1) Remove all tools from the vehicle.
- 2) Inspect reinstalled interior trim parts for proper panel fit.
- 3) Reset radio presets to the recorded setting.
- 4) Turn ignition to ON position.
- 5) Confirm proper radio operation.
- 6) Initialize sun roof, and power window operation.
- 7) Confirm proper operation of the rear window washer fluid.
- 8) Turn ignition to off position.

CAUTION

During restoring, please use caution so as not to cause the stacking of the vehicle's harness, or damage any other parts.